

**CODE NUMBER**

3315408BT

**DESCRIPTION**

Battery + Turbine Power Supply, Below Deck Manual Mixing Valve, Polished Chrome Finish, 0.5 gpm, Multi-Laminar Spray, Infrared Sensor, Optima® Battery-Powered Deck-Mounted Low Body Faucet.

**DETAILS**

- Flow Rate: 0.5 gpm (2 Lpm) (0.5GPM)
- Spray Type: Multi-Laminar (MLM)
- Sensor Type: Infrared (IR)
- Mounting Type: Single Hole ( )
- Power Supply: Battery + Turbine (TUR)
- Temperature Mixer: Below Deck Manual Mixing Valve (BDM)
- Finish: Polished Chrome (CP)
- Factory Default Timeout: 30s
- Factory Default GPC: 0.25

**FEATURES**

Commercial Grade Faucet, ADA Compliant, Cast Brass Spout, Quick Connect Fittings, Integrated Water Shut-off, Wireless Settings Adjustment, On-demand or Metered activation, Hygienic Line Flush, Water Usage and Battery Strength Reporting, Self-adapting Sensor

**ELECTRICAL SPECIFICATIONS**

- Battery Life: 3 years 8,000 cycles/month
  - Optional power harvesting significantly extends service life
- Sensor Range: 4" - 5" (102 - 127mm)
- Timeout Adjustment Settings: 30s

**POWER SUPPLY OPTIONS**

- 6VDC Plug Adapter (sold separately)\*
- \* when converting units to hardwired with battery back-up

**VIDEOS**

- ▶ Sloan Optima Below Deck Faucet
- ▶ PVD Special Finishes
- ▶ Sloan Connect App®

**DOWNLOADS**

- [Optima Smart Faucet Below Deck Installation Instructions](#)
- [Faucet Spray Heads Repair and Maintenance Guide](#)
- [Optima EBF-415 / ETF-410 Repair & Maintenance Guide and Parts Breakdown](#)
- [Trim Plate Guide](#)
- [Additional Downloads](#)

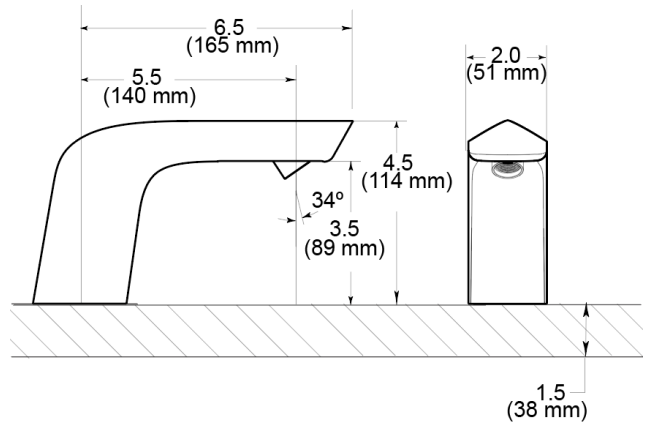

**COMPLIANCES & CERTIFICATIONS**

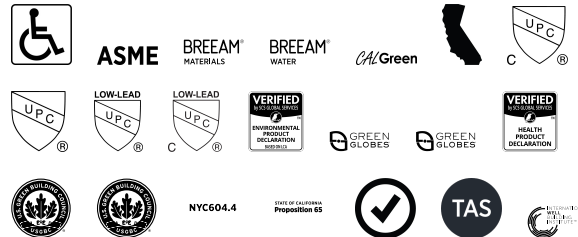

(ADA Compliant, ASME A112.18.1 Compliant, BREEAM Materials Credit, BREEAM Water Credit, CalGreen Compliant, CEC Compliant, cUPC Certified, UPC Certified, UPC Low Lead Compliant, cUPC Low Lead Compliant, EPD, Green Globes Materials & Resources Credit, Green Globes Water Credit, HPD, LEED Materials & Resources EPD Credit, LEED Materials & Resources HPD Credit, NYC604.4, Proposition 65, Satisfies LEED Credits, TAS, WELL Building Standard)

**RECOMMENDED SPECIFICATION**

Faucet shall include cast brass body, quick-connect fittings, twist-off/shut-off solenoid assembly, removable battery cartridge, flexible power supply and allow adjustment of settings wirelessly via Apple or Android smartphones.

**Sloan 10500 Seymour Ave, Franklin Park, IL 60131**  
 Phone: 800.982.5839 • Fax: 800.447.8329 • [sloan.com](http://sloan.com)

**NOTES**

All information contained within this document subject to change without notice.

Looking for other variations of the EBF-415 product? [View the general spec sheet with all options.](#)

[Find a matching soap dispenser](#) for this faucet.

[Find a compatible sink](#) for this faucet.

**WARRANTY**

3 Year

**ROUGH-IN**

